

TS9085 *New*

www.microgenelectronics.com

FM Modulation and AF Spectrum Analyser



2009 Technical specification
Issue 1.2

microGen
electronics™

The TS9085, FM Modulation and AF Spectrum Analyser, has been designed for precision monitoring of FM Radio Broadcasts. Connected to a standard Windows PC, via a USB port, it's user friendly interface displays all modulation data on screen for analysis.

Audio outputs are provided for high quality headphone or loudspeaker monitoring, with full RDS decoding available, with live 'off-air' data recording. Extensive automatic logging of broadcast data with the included **iLog** software. Remote control is possible with simple text file commands allowing the unit to be controlled from 3rd party software applications.

Unique to this class of product is a **FFT Spectrum Analyser** for precise audio analysis.

The enclosure is a custom designed dual-chamber aluminium extrusion, providing excellent screening between the analogue and digital circuitry and providing an extremely robust case for field use.

This combination provides broadcast engineers, whether working on-site or as a mobile unit, with a competitively priced instrument, compatible for use around the world.

Digital phase FM demodulator an ultra linear design. Two feedback loops maintain accuracy over time and temperature by comparing deviation amplitude and phase to a 20ppm voltage reference band-gap diode. This provides a virtually calibration free instrument. All measurements of deviation, modulation power, pilot level and RDS sub-carrier are referenced to this, as are any other baseband measurements made with the spectrum analyser.

FFT Spectrum Analyser 10Hz to 100kHz with 16 bit sampling, achieves a 100dB dynamic range. This can be extended to greater than 110dB with waveform averaging, allowing signals below noise to be observed and measured.

IF Amplifier, dual band. The narrowband is set with multistage selected ceramic filters and the wideband is set with a proprietary Gaussian response LC filter, computer optimised and equalised for minimum overshoot. These filters allow precise 'off-air' measurements, offering low levels of distortion for high quality audio monitoring, via the headphone output or loudspeakers.

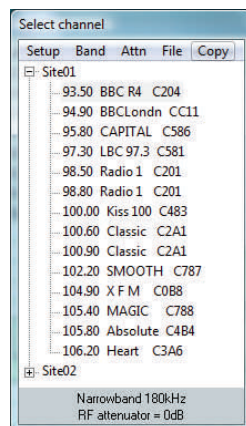

Software DSP stereo decoder with excellent phase matching between channels, with lower distortion and noise than traditional analogue types.

Stereo monitor with left and right channels shown on a time domain display. An additional 2D vector stereo quality display gives a visible guide to left and right channel behaviour.

Multiplex record and playback with full stereo audio monitoring using PC sound system. This feature records the raw USB data from the TS9085 directly to hard disk. This can then be replayed at any time, giving a live 'off-air' monitor. A recording can be made from any frequency on the channel list and is only limited by the hard-disk size.



Antenna attenuator providing up to 30 dB attenuation, with user selectable 10dB steps. Different attenuator values can be assigned to each frequency on the channel list.

IF input at 10.7MHz on standard BNC 50 ohm socket provides flexible monitoring with the front-end shut down automatically. This is achieved with a simple software switch.

IF filter output at 10.7MHz from a standard BNC 50 ohm socket, allows the user to feed external equipment.

Balanced audio outputs for left and right channels

Class AB audio amplifier for high quality audio monitoring on headphones or external loudspeakers. Additional audio stereo monitoring is available on the PC sound system.

USB powered, means that no other power source is required. Running from a Laptop computer, provides for mobile monitoring and logging of radio broadcasts.

Windows iLog software is supplied with the unit, providing complete control and display of all measurements. This will run on a standard desktop or laptop PC.



TS9085 I/O connections

Front view



Rear view



I/O connections front:

- BNC multiplex signal unbalanced output.
- BNC analyser input, for external multiplex signal or any AF signal for evaluation with the internal Spectrum Analyser.
- BNC alarm output. Used by the Autolog function in software. This will sink 10mA.
- BNC IF 10.7MHz filter out. This is the signal fed to the internal IF log amplifier.
- 3.5mm jack for AF stereo headphone monitoring.
- USB power blue LED.

I/O connections rear:

- BNC 50 ohm unbalanced antenna input.
- BNC External IF 50 ohm 10.7MHz input
- BNC RDS 57kHz band-pass output
- 3.5mm stereo jack balanced output for left and right channels. These outputs have been specially designed to be very low impedance, which makes them suitable for driving balanced line or loudspeakers.
- USB connector. This is compatible with USB1.1 and USB2 standards. The unit is powered from this, with no other power supply required. All control signals and data are fed to and from this connector.

TS9085 system diagram

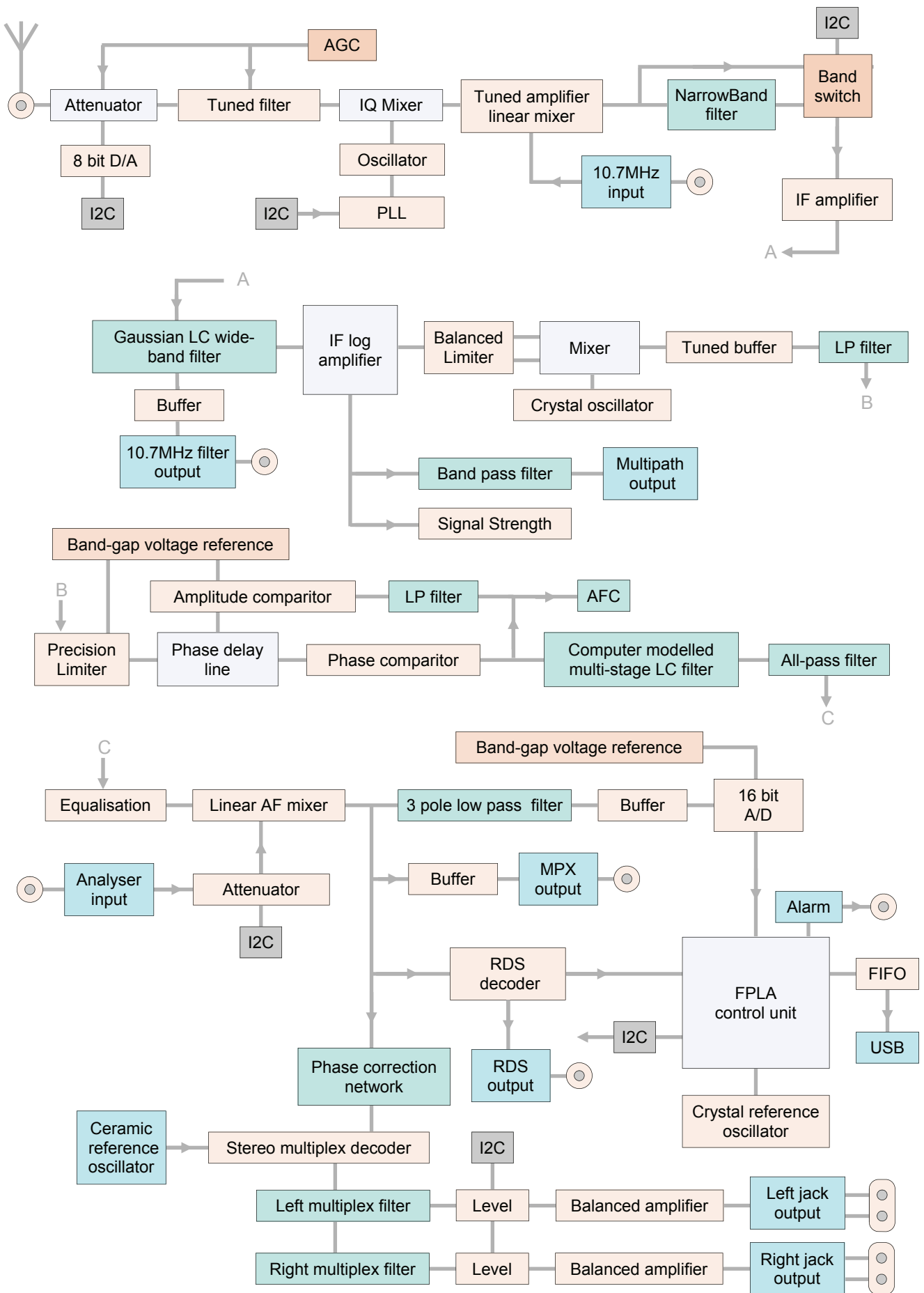

iLog Windows software

iLog application iLogV4.09 beta . . . screen dump at 1280 x 1024 screen resolution

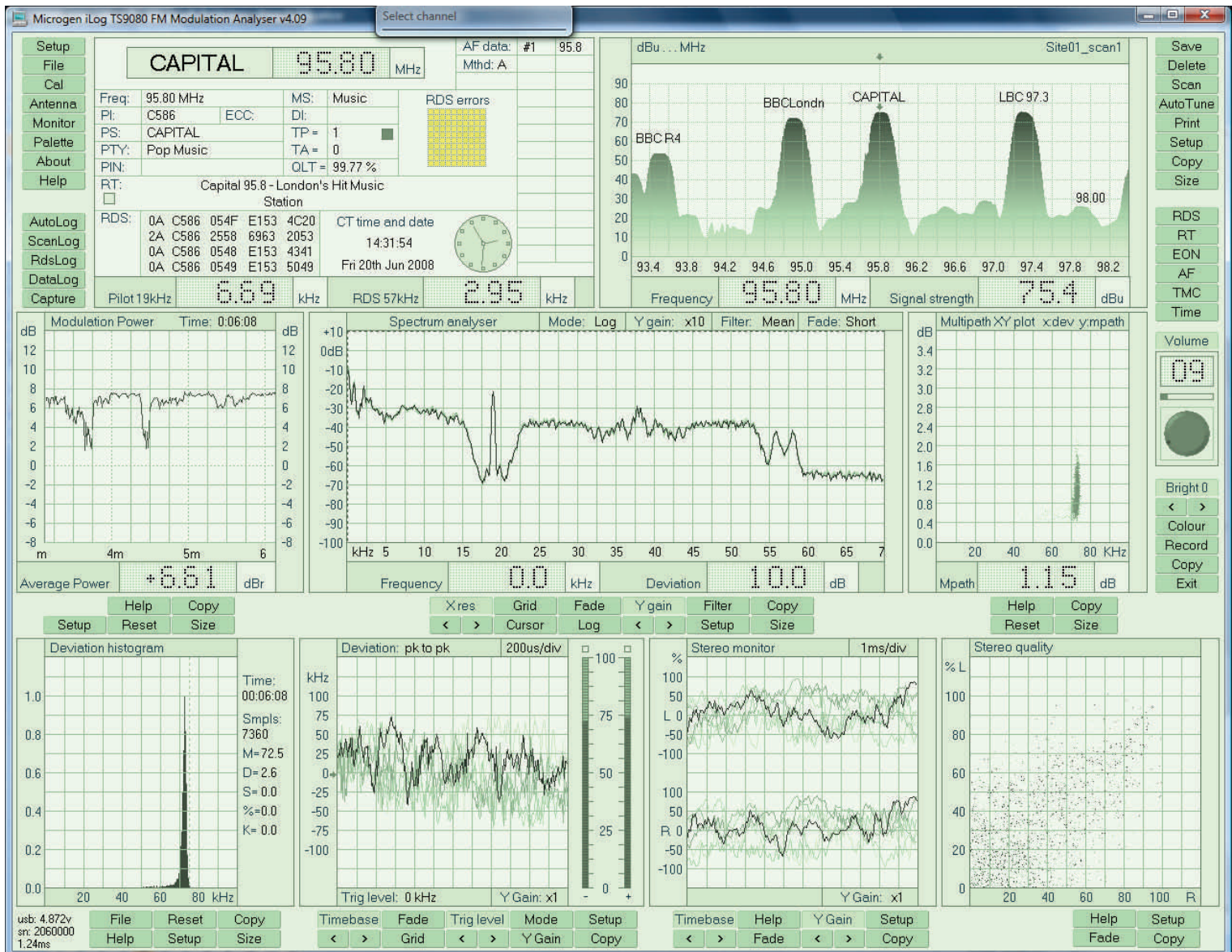

FM Modulation analyser features:

- High performance FM receiver and Modulation Analyser providing broadcast measurements over the band 87.5 to 107.9 MHz in 10kHz steps
- Signal strength with 80dB range and frequency scanning
- FM deviation 0 to 100kHz with histogram
- Modulation Power calculated with 32bit floating-point precision
- Multipath with XY plot
- Pilot 19kHz amplitude
- RDS 57kHz sub-carrier
- Left and right channel decoding, with stereo quality graphical readout
- Automatic logging of signal strength, pilot and RDS carrier
- Remote control with simple text file commands

RDS/RBDS decoder features:

- Full RDS/RBDS decoding, with signal quality readout.
- Decoded groups PI,PTY,PS,RT,CT,PIN,AF,TA,TP,DI,MS,EON
- RT automatically saved to file

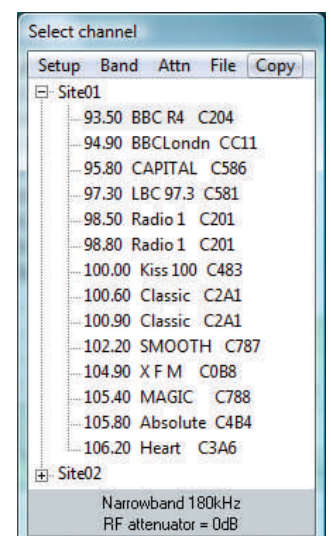

FFT Spectrum Analyser

This 32bit FFT Spectrum Analyser, takes advantage of the high quality 16 bit SAR A/D convertor, extracting frequency detail well into the noise of the signal.

This convertor is fed by an ultra low distortion buffer, with less than 0.0006% distortion+noise, and a computer optimised LC anti-alias filter. A software controlled passive input attenuator network, allows for scaling of the signal under measurement for greater flexibility. Any measurements taken can be cut and pasted into other applications.

This is a high quality analyser that can be used for AF analysis over a bandwidth of 100kHz.

- 16 bit sampling
- Precision base-band FFT Spectrum Analyser covering 10Hz to 100kHz
- Dynamic range of 100dB with a resolution of 20Hz
- Multiplex signal analysis
- External Multiplex analyser using the external BNC input
- Audio analyser using the external BNC input
- Linear or logarithmic scale with full cursor measurement

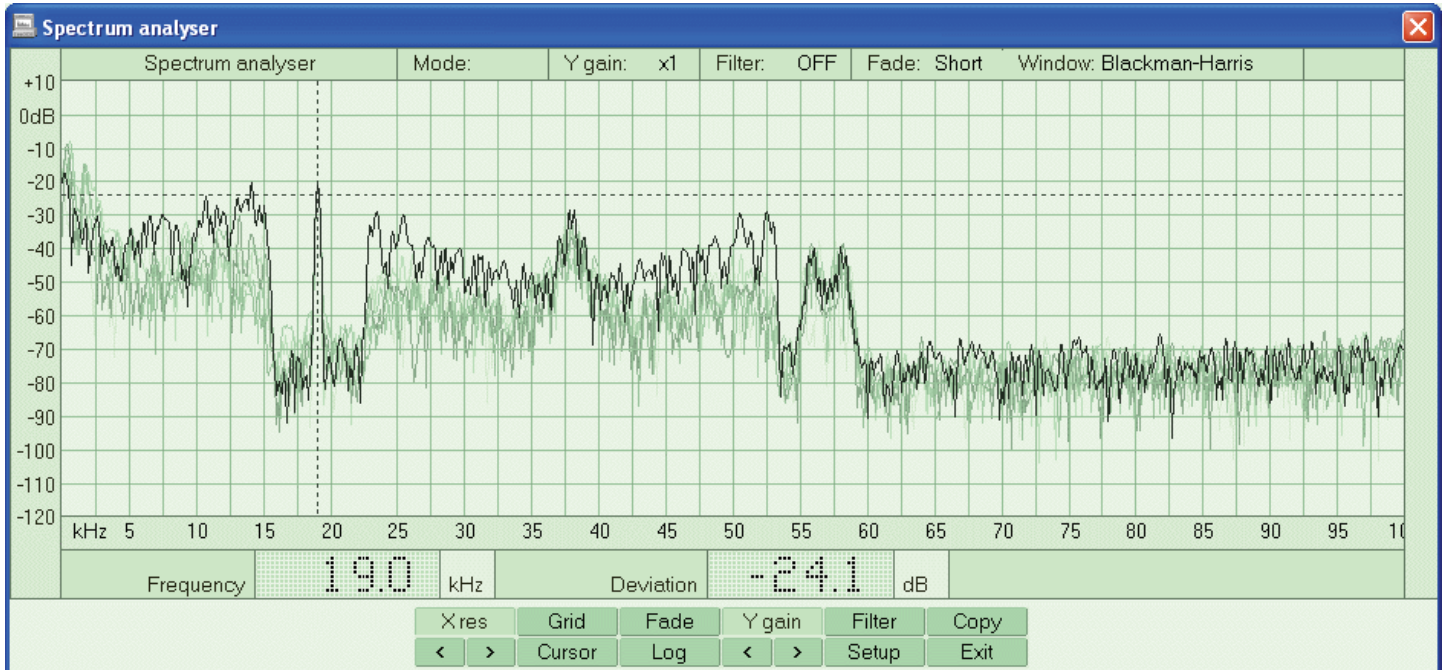

- The FFT spectrum analyser feature, provides a valuable tool for examining the FM multiplex signal. The TS9000 units sampled at 12 bits, but on the new TS9085 this has been increased to 16bits using a very high quality A/D converter. This converter has a very low spurious output, coupled with low distortion and noise.
- With signal averaging it is possible to detect signals below noise. This will extend range to greater than 110dB.
- Various sample windows can be applied, Hanning, Hamming, Blackman-Harris etc, providing versatile measurement.
- The spectrum below details just the 57kHz RDS sub-carrier sideband modulation at a resolution of 250Hz per division.



RF BROADCAST SPECTRUM

- The FM Broadcast frequency band can be scanned from 87.5 MHz to 107.9 MHz. This window can be resized to view any particular frequency. If the radio channel is transmitting it's PS name then this will be automatically displayed
- The AutoTune feature provides a completely automatic channel search and save function
- The Windows iLog software provides extensive logging, manual or automatic, with an alarm on error.

RF Broadcast spectrum 87.5MHz to 107.9MHz

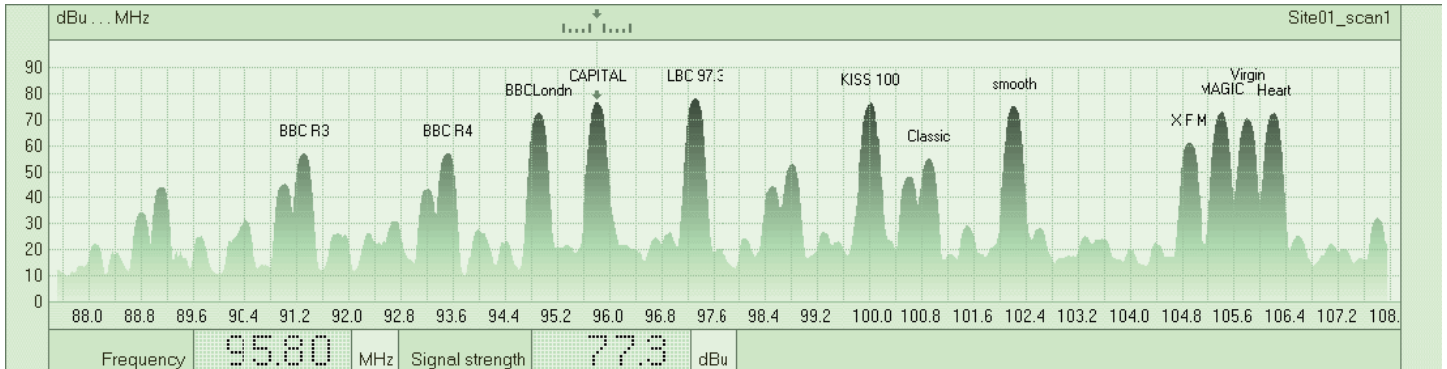

- The window above shows a complete frequency scan from 87.5MHz to 107.9MHz. The digital readout gives the frequency and signal strength of the channel tuned. This spectrum can be printed out as a hard copy for future reference.

RF Broadcast spectrum detailing 95.8MHz

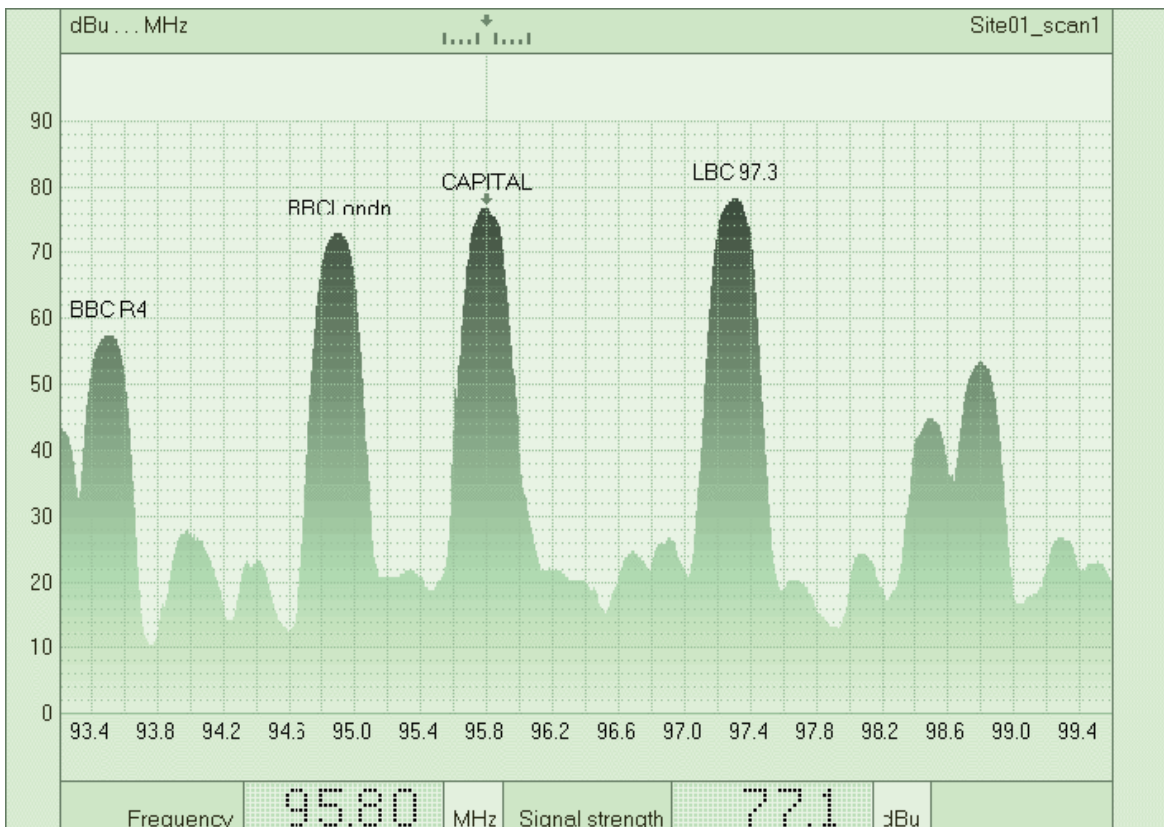

- The window shown here, details just a small frequency range at 10kHz resolution. The vertical scale has doubled to show 2dB increments.
- This frequency scan can be dragged with the computer mouse to show any frequency of interest.
- For strong signal areas, a user settable antenna attenuator can be selected. This has three settings of -10dB, -20dB and -30dB.
- These windows can be copied and pasted into any suitable application.

FREQUENCY DEVIATION

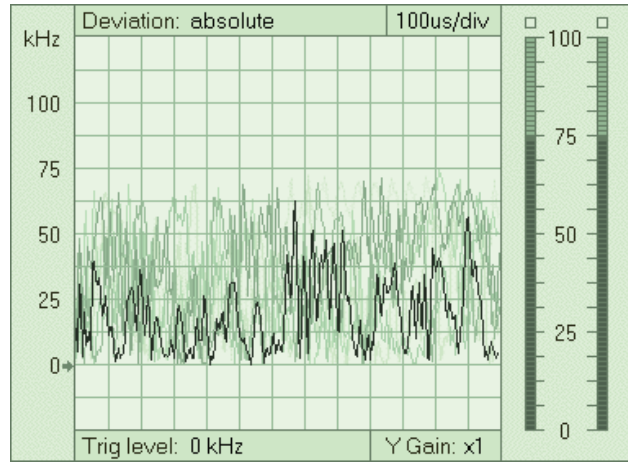
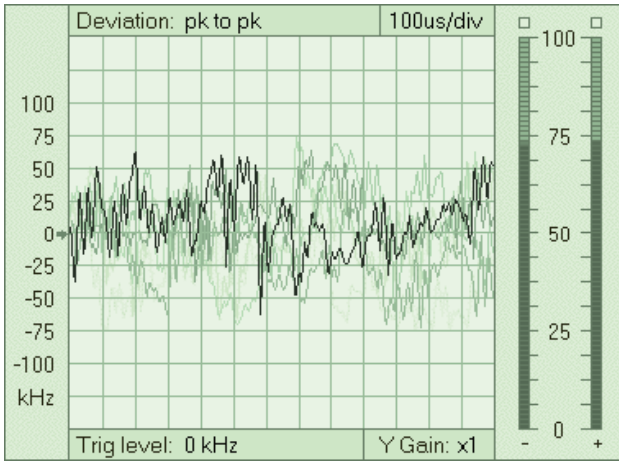

- The Multiplex signal can be viewed in the time domain with an oscilloscope type display
- The time-base can be set from 10ms/div to 10us/div. The Y-axis has a x10 function. The trigger point can be user set or automatic
- The deviation window shows a typical trace with the positive and negative deviation bar graphs.
- This deviation window now shows a typical trace set for absolute signal readings

FREQUENCY DEVIATION HISTOGRAM

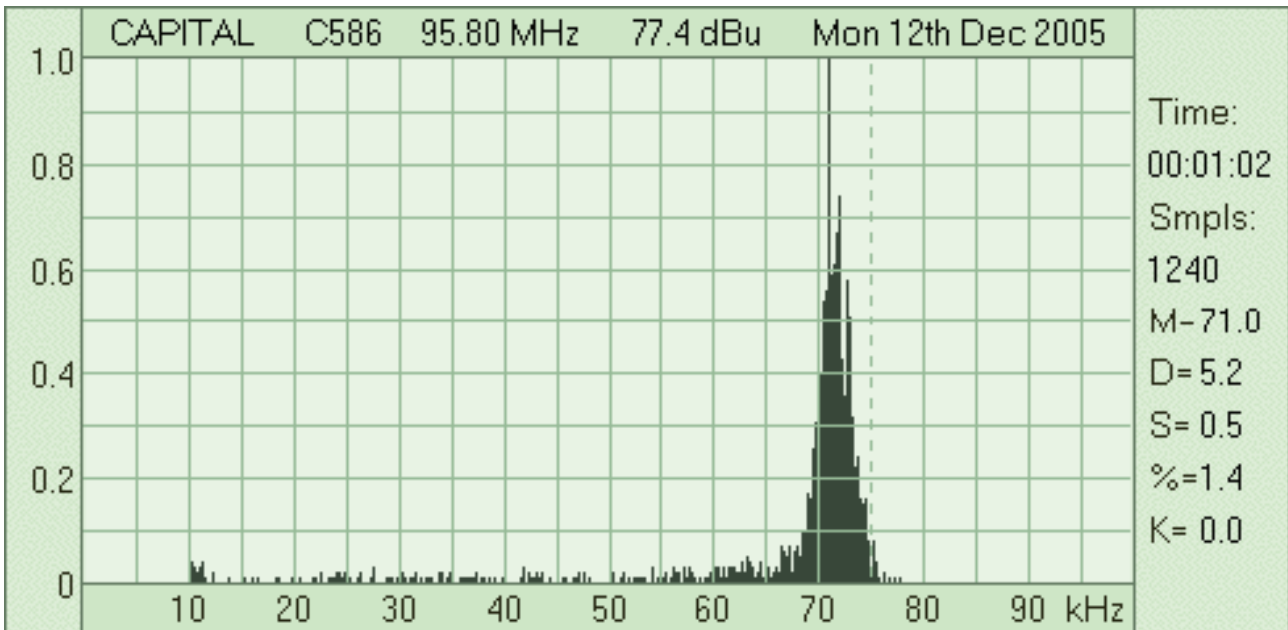

- The frequency deviation histogram provides the best way to assess deviation levels over any period of time
- A histogram can be viewed in real time from this window. The following variables are calculated from the collected data.
 - T Lapse time measured in minutes and seconds
 - The number of samples taken
 - M The mean value of deviation
 - D The quadratic mean value of deviation
 - S The mean of samples above 75KHz
 - % The percentage of samples above 75KHz
 - K Equals $S \times \%$

MODULATION POWER

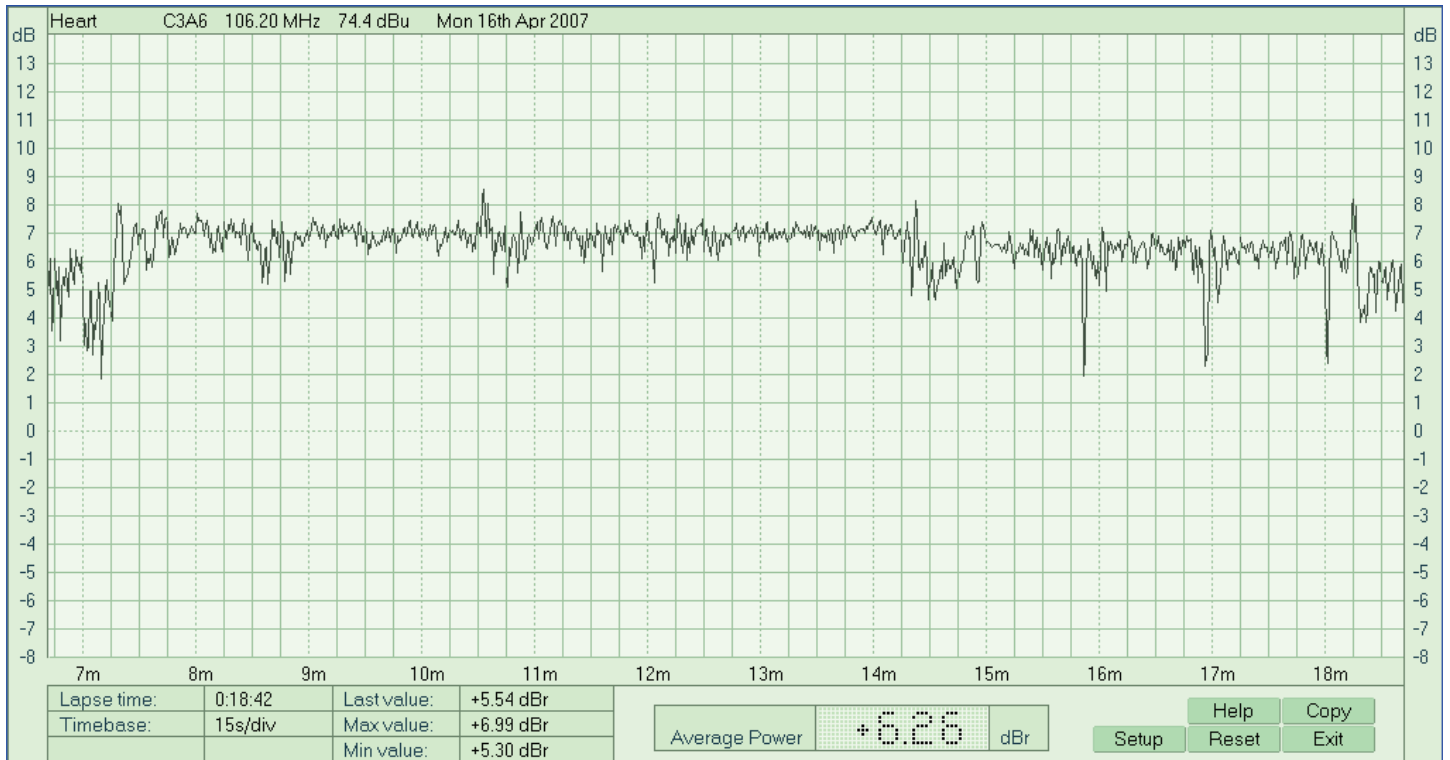

- Modulation Power is calculated with 32bit floating-point precision from the 16bit sampled multiplex signal. This provides the most accurate way of calculating modulation power compared to the more traditional analogue methods with their inherent problems of dynamic range and temperature drift.
- The time-base can be set to run from 15sec/div to 30min/div and resets on channel frequency change, or can be user reset at any time.
- The graph continuously scrolls over any period of time and can be printed as required
- The average power is calculated with reference to the EBU standard 0dBr.
- Every minute the minimum and maximum values are recorded, with the last value shown for the previous recorded minute.
- The Lapse time gives the recorded time from frequency change or user reset.
- By simply clicking the Copy button the graph can be copied, via the clip-board, and pasted to any other application.

STEREO MONITOR

- Unique to the TS9085 is that the Stereo multiplex audio is decoded by a software algorithm. The 19kHz pilot is detected and phased locked to a narrowband filter and the left and right channels are then extracted with a synchronous detector. This new method of decoding gives excellent phase matching between channels. De-emphasis is finally applied with a further digital filter. No close tolerance components are required or any alignment necessary with this technique.
- The extracted left and right audio signal is then passed, via Windows, to the Sound Card for audio monitoring.
- The **iLog** software provides for digital recording of the USB data. This provides the complete monitoring of a Radio Channel, i.e. it's multiplex data is decoded for deviation, RDS data, and it's stereo audio signal. This will allow an engineer to take a snap-shot of a radio channel, save it to file, and later play it back as if an 'off-air' broadcast.

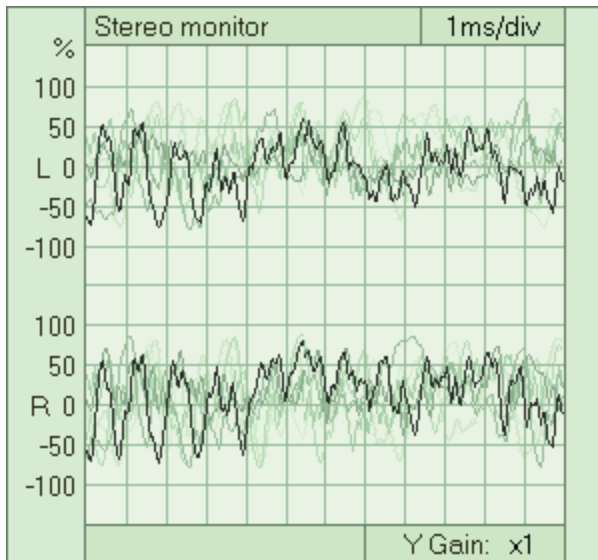

- Shown here is the left and right channels.
- The time-base can set as required and the vertical gain can be set to x1 or x10, for detailed inspection.

STEREO QUALITY

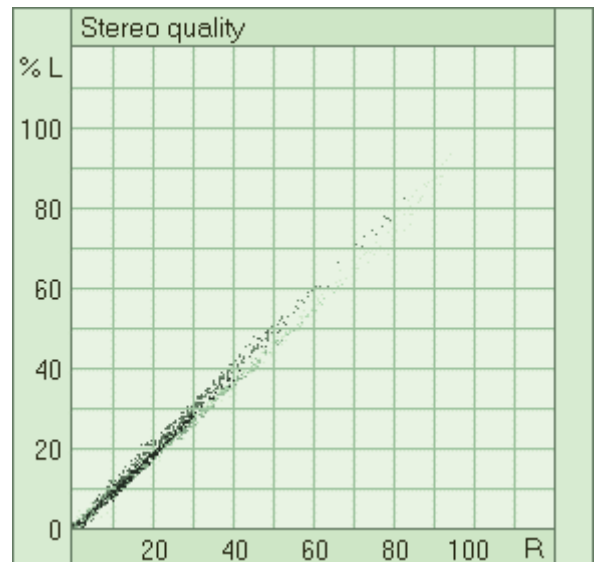
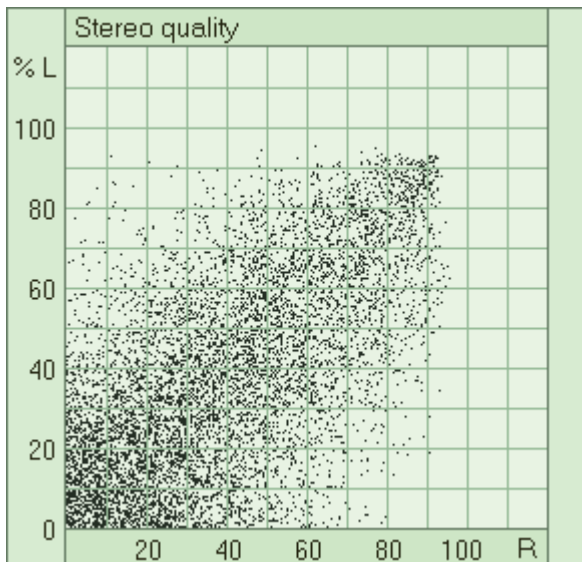

- To visualise the stereo quality, the left channel is set to the vertical axis and the right channel to the horizontal axis. The resultant 2D display gives an instant display of the stereo content from the frequency being monitored.
- The graph on the left displays a typical stereo broadcast and on the right, it displays mono broadcast, which in this case is speech. If the left or right channels are missing then the display will not show symmetrically.

RDS DECODER

- The RDS decoder will decode groups PI,PTY,PS,RT,CT,PIN,AF,TA,TP,DI,MS,EON. This data can be viewed on-screen as it arrives and it can be stored to hard-disk.

Group rate: 10 sec		Received Blocks	500
0A 45	0B	Block errors	0
1A 11	1B	Block error ratio	-
2A 23	2B	RDS quality %	100.0000
3A	3B		
4A	4B		
5A	5B	2A C204 2016 656E 204E	
6A 2	6B	14A C204 E005 390D C202	
7A	7B	0A C204 001F F13C 3420	
8A	8B	2A C204 2017 6577 732E	
9A	9B	0A C204 001C 3932 2042	
10A	10B	1A C204 1000 80E1 6B5E	
11A	11B	14A C204 E005 3206 C202	
12A	12B	0A C204 0019 4738 4243	
13A	13B	14A C204 E005 4707 C202	
14A 33	14B	0A C204 001A 4243 2052	
15A	15B	2A C204 2018 2020 2020	
		14A C204 E005 3809 C202	

Group data

- Un-decoded continuous RDS data is displayed in this window.
- Group repetition rates are calculated over a sixty second period.
- RDS quality is given to four decimal places.

Group: 14A		Network: 3		TA: 0		PI: C201		PS: Radio 1			
PTY: Pop Music				LINK: 8001		PIN: 6B00 13th at 12:00					
AF		Map 1		Map 2		Map 3		Map 4		AM	
ON	ON	TN	ON	TN	ON	TN	ON	TN	ON	TN	ON
		93.5	98.8	94.2	97.7						
		93.2	98.5	94.4	99.5						
		92.5	97.7								
		94.6	99.2								
		93.1	98.3								
		94.1	99.3								
		94.2	99.4								
		94.4	99.6								
		92.8	98.0								
		94.5	99.7								
		93.0	98.2								
		93.9	99.1								
		92.9	98.2								
		93.3	98.5								
		94.3	99.5								
		92.7	97.9								
Group: 14B		PI:		TP:							
				TA:							

EON data

- A continuous update of EON data is available for all networks received.
- When all data has been captured, it can be stepped through for inspection, or printed out for hard copy.

Radio Text	<input type="checkbox"/>	Classic 100.90 MHz	Tue 13th Dec 2005
13:57:13		You can reach Classic FM by telephoning 020 7343 9000...	
13:57:28		Our address is Classic FM, PO Box 2834, W1A 5NT.	
13:57:44		Classic FM on the internet: www.classicfm.com	
13:57:59		Relaxing Classics at Two...with Nick Bailey	
13:58:14		Relax - it's Classic FM Relax - it's Classic FM	
13:58:28		You can reach Classic FM by telephoning 020 7343 9000...	
13:58:43		Our address is Classic FM, PO Box 2834, W1A 5NT.	
13:58:58		Classic FM on the internet: www.classicfm.com	
13:59:13		Relaxing Classics at Two...with Nick Bailey	
13:59:28		Relax - it's Classic FM Relax - it's Classic FM	
13:59:43		You can reach Classic FM by telephoning 020 7343 9000...	
13:59:59		Our address is Classic FM, PO Box 2834, W1A 5NT	
14:00:13		Classic FM on the internet: www.classicfm.com	
14:00:28		Relaxing Classics at Two...with Nick Bailey	
14:00:43		Relax - it's Classic FM Relax - it's Classic FM	
14:00:58		You can reach Classic FM by telephoning 020 7343 9000...	

RT history

- Sixteen RT messages are captured and displayed in the RT window.
- These messages can be logged directly to hard disk.
- Any number of messages to capture can be set and they will be stored as ASCII text.
- These can be cut and pasted into any text file. Any repeat messages can be ignored.

iLog Remote Control

Background:

We have many requests to control the TS9080/85 from remote software. This has been possible in the past by providing the USB software protocol for the hardware. However, the control commands and the complexity of the returned data has posed considerable problems for would-be software developers. To solve this a new and extremely simple shared text file system has been introduced into the iLog software.

Basic operation:

When the iLog application is run, it automatically generates a simple text file called iLog.txt

An application can now control the TS9080/85 by writing a single line of text to this file.

The iLog application automatically reads this line of text every 100ms, executes its commands and returns an acknowledge by overwriting this control text with an 'action complete code'.

If the application has requested data, the iLog application will write this data back as a single line of text.

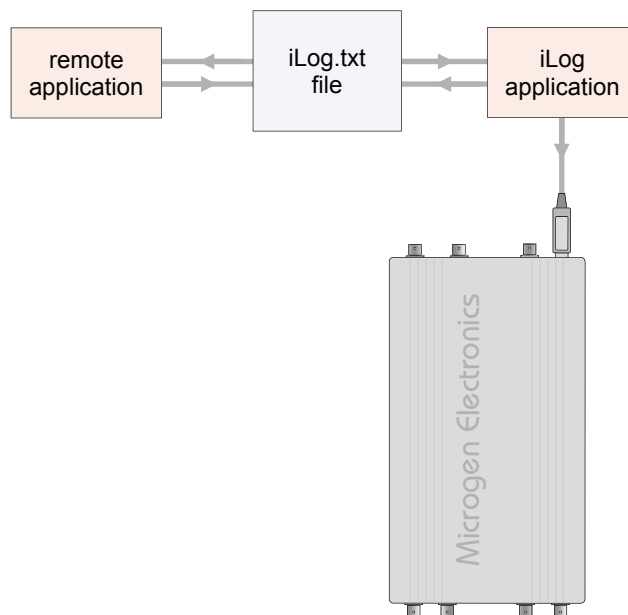

To control the TS9080/85:

Tx=Control code, frequency, attenuator, volume, screen size, clear histogram, clear modulation power

Control code: 2

Frequency: frequency x100

Attenuator: 0=0dB 1=-10dB 2=-20dB 3=-30dB

Volume: 0 to 63

Screen size: 0: normal large screen 1: collapsed small window

Clear histogram: 0: clear histogram data 1: normal operation

Clear modulation power: 0: clear modulation power data 1: normal operation

Example:

Tx=2,9580,2,40,1,0,0 This will set frequency to 95.8MHz, attenuator -20dB, volume 40, small screen, and clears histogram and power

To receive data from the TS9080/85:

Tx=3 This will request to receive information, in the format:

Info: frequency, PS, PI, signal strength, pilot level, rds carrier, multipath level, average modulation power, time, date,TA

Example:

Info: 95.80 MHz,CAPITAL,C586,72.6 dBu,6.45 kHz,2.47 kHz,1.2 dBu,3.86 dB,20:33:54,Tue 17th Mar 2009,0

TS9085 TECHNICAL DATA

System Measurements:	
Deviation:	+100kHz to -100kHz
Modulation Power:	-8dBm to +12dBm (0dBm ref 19kHz)
Pilot 19KHz:	dB or %
RDS carrier 57KHz:	dB or %
Signal Strength:	85dBu full scale range
Multipath:	10dBu full scale range
Stereo:	0 to 100% modulation

Multiplex signal:	
Bandwidth: wideband	0.1Hz to 80kHz < 0.4dB 0.1Hz to 100kHz < 1.0dB
Bandwidth: narrowband	0.1Hz to 80kHz < 1.0dB 0.1Hz to 100kHz < 4.0dB
Deviation accuracy:	0 to 75kHz < +/-0.5% (1kHz test sinusoid)

System parameters	Min	Typical	Max	Units
RF Bandwidth	87.5	-	107.95	MHz
Input impedance		50		ohms
Image rejection		85		dB
Sensitivity		2.8		uV
RSSI resolution		0.1		dB
Multipath resolution		0.1		dB
Pilot 19KHz range	18.95		19.05	kHz
RDS 57kHz range	55.5		58.5	kHz
THD narrowband		0.100		% @ 1kHz
THD wideband		0.015		% @ 1kHz
Stereo cross-talk		42		dB

Signal connections: TS9085

Front connections:

BNC 50 ohm IF filter output 100mV RMS at 10.7MHz with 80dBu antenna signal
BNC MPX multiplex. Output 50ohms 0dBm at 75KHz
Jack 3.5mm Stereo monitor for headphone listening
BNC 50 ohm Alarm 10mA output
BNC 50 ohm IF input at 10.7MHz
BNC Analyser input >10Kohms 0dBm (FM multiplex or audio spectrum analyser)

Rear connections:

BNC Antenna input 50ohms
USB 1.1 and 2 compatible (Not suitable for non-powered hubs)
Jack 3.5mm Left channel balanced output
Jack 3.5mm Right channel balanced output
BNC RDS 57kHz band-pass output

Dimensions: TS9085

295mm x 147mm x 36.5mm
Weight 1.1 Kg

Provisional specification:

Document: TS9085_spec_18may09.pub

Spectrum Analyser:	
Dynamic Range:	>100dB
Dynamic Range Averaged:	>110dB
Bandwidth	100kHz
Resolution:	20Hz



Screen resolutions:

XGA	1024 x 768
WXGA	1280 x 800
SXGA	1280 x 1024
WXGA+	1440 x 900
SXGA+	1400 x 1050
UXGA	1600 x 1200
WSXGA	1680 x 1050
WUXGA	1920 x 1200

System requirements:

TS9085 iLog software runs under Windows98/2, Me, 2000, XP and Vista.

Minimum usable system: Windows98/2 running on a 1 GHz Celeron.

Recommended system: WindowsXP/Vista 2+ GHz Pentium/Athlon.

Requires a minimum of 64MBytes of RAM.

Temperature: Operating: 5degC to 40degC
Storage: -10degC to 50degC